

SX1308

Boost Converter

Features

Claimed specification

- Input voltage: 2-24V
- Output voltage: 2-28V, adjustable
- Size: 16mm x 23mm x 14mm
- Max. output current: 2A
- 1.2MHz switching frequency.

Additional information

- Starts working at about 3 V
- 1 - 9mA idle current
- Doesn't come close to 2A output current.
- Output Voltage starts to decrease when the input current comes near 2A.
- Output voltage regulation is not very stable.

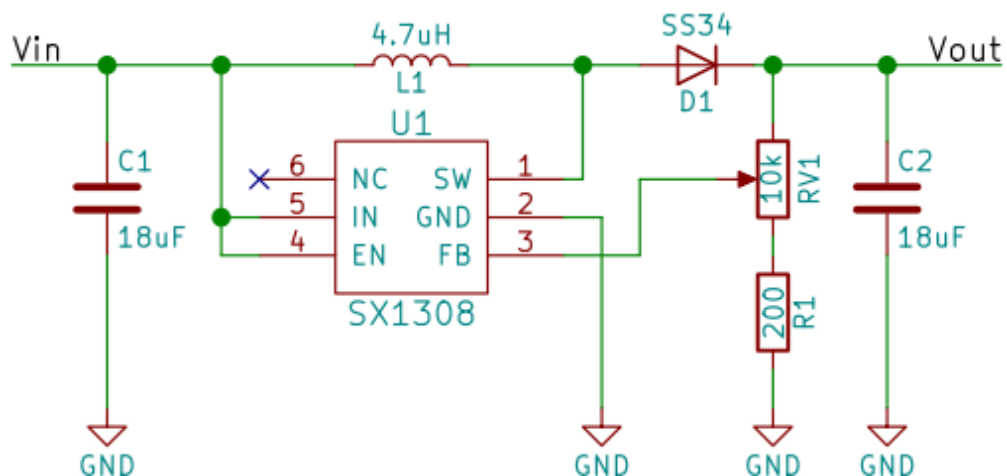
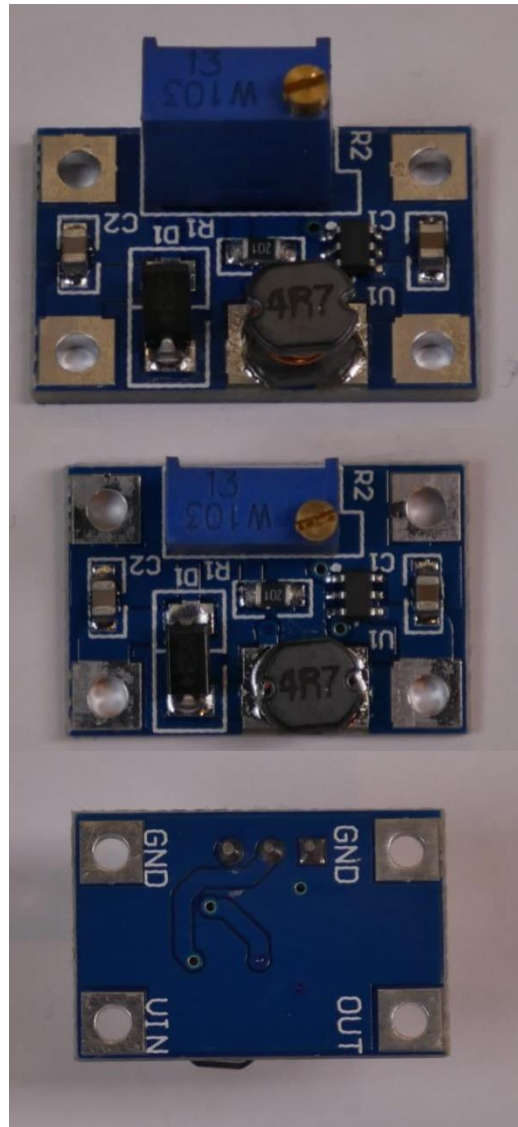

SX1308

Boost Converter

Efficiency

5V Output

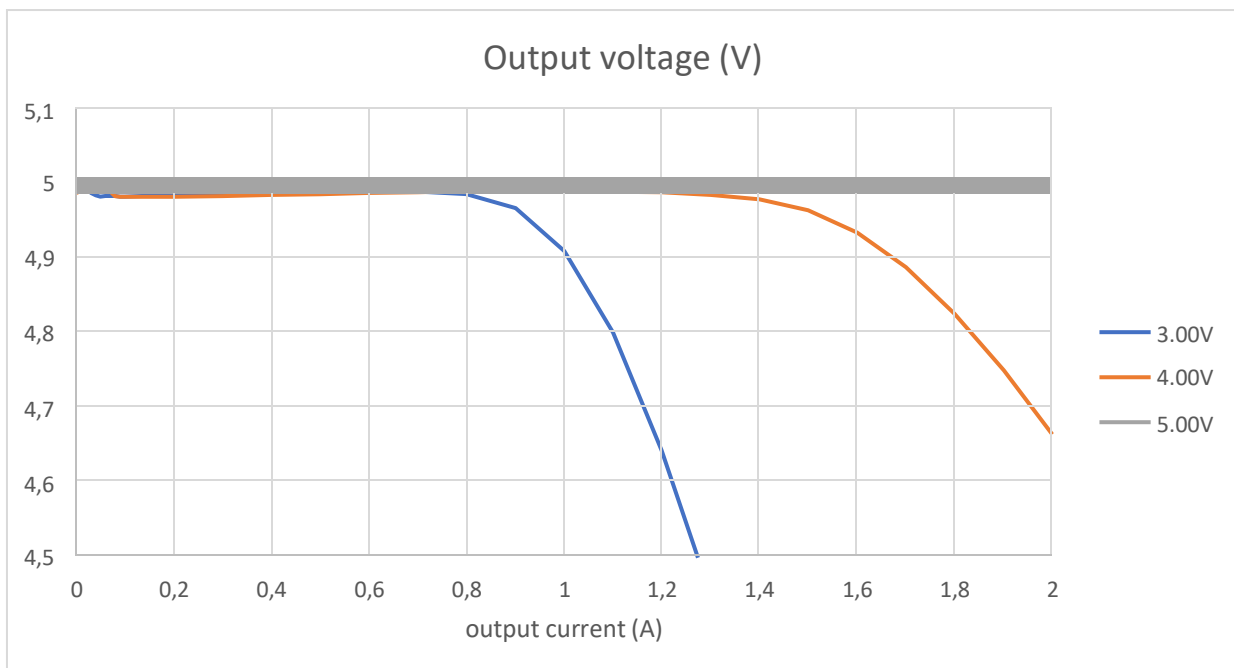
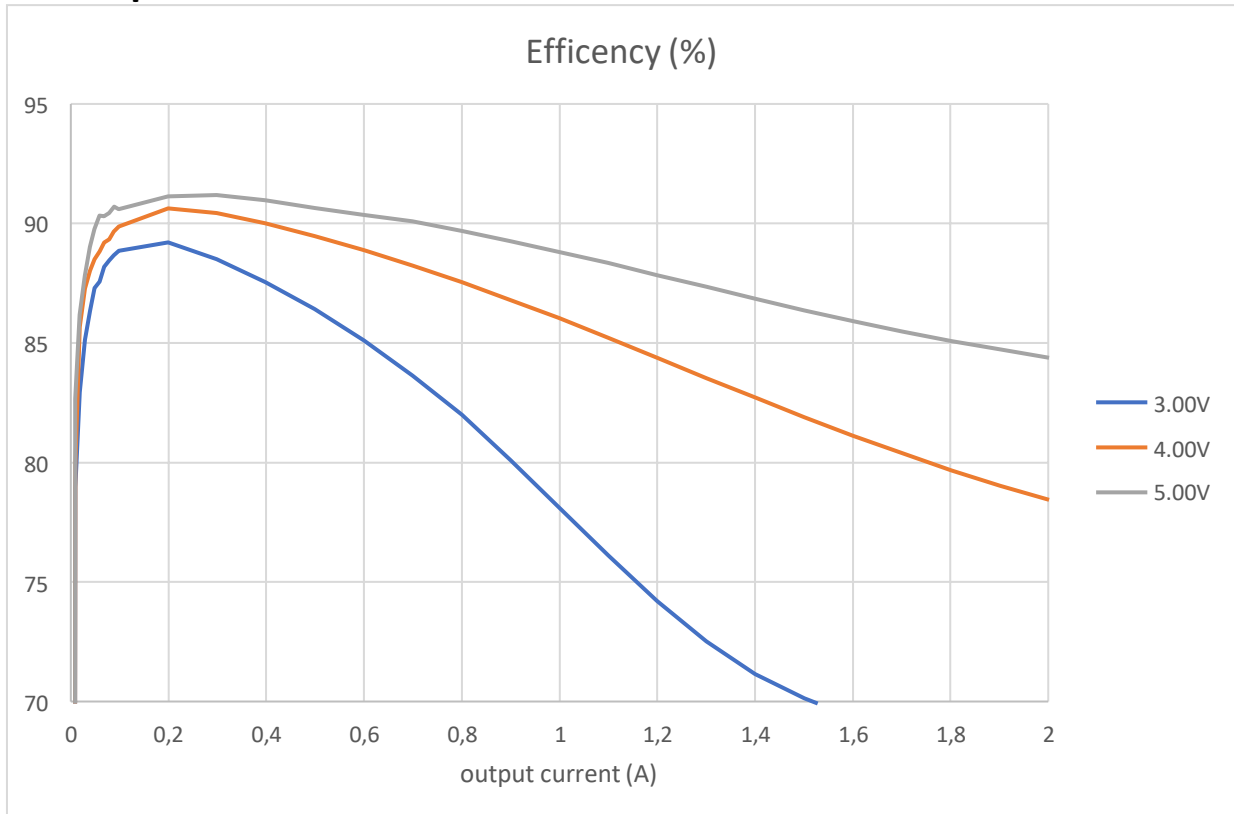

SX1308

Boost Converter

9V Output

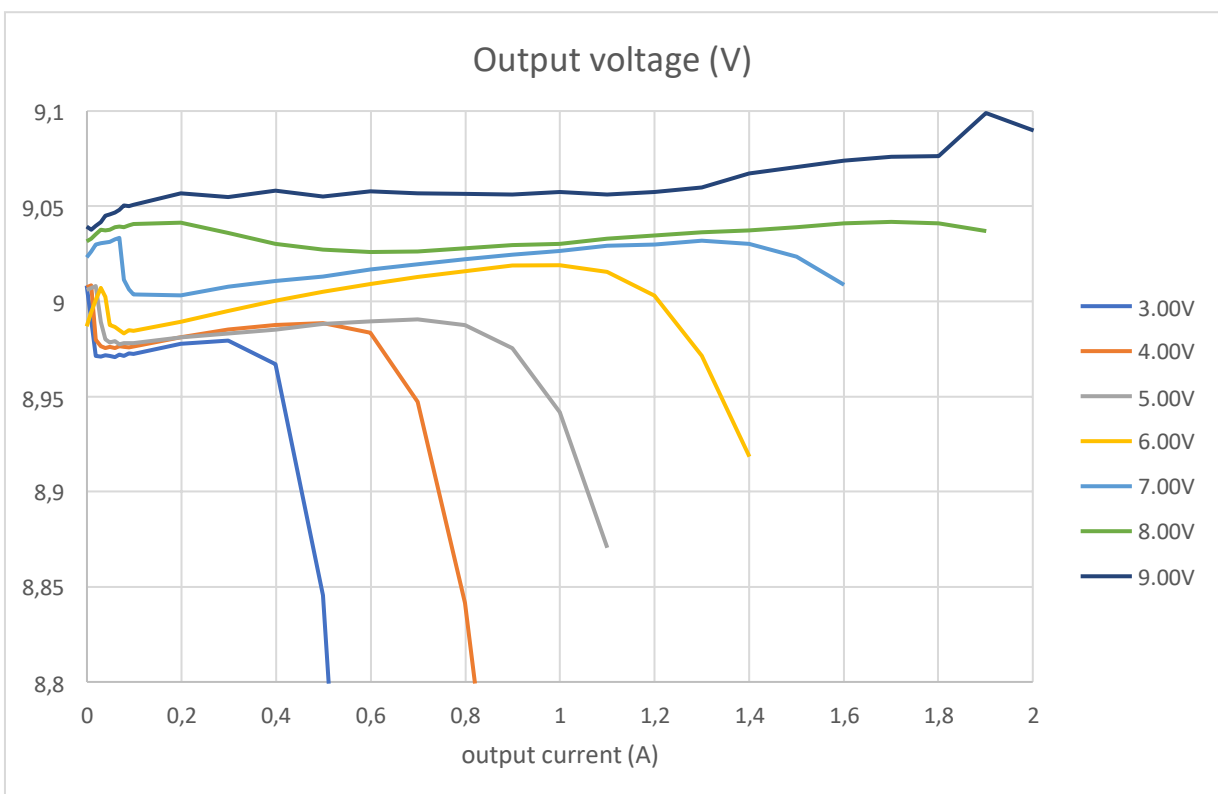
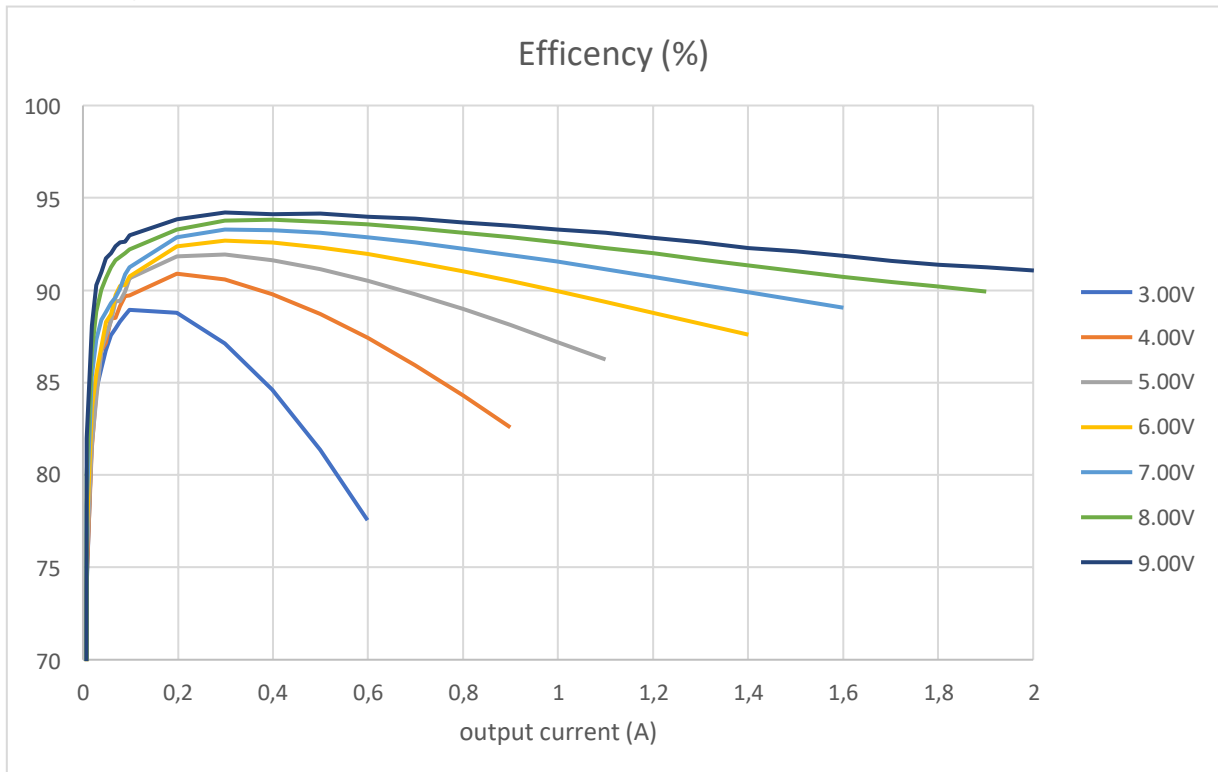

SX1308

Boost Converter

12V Output

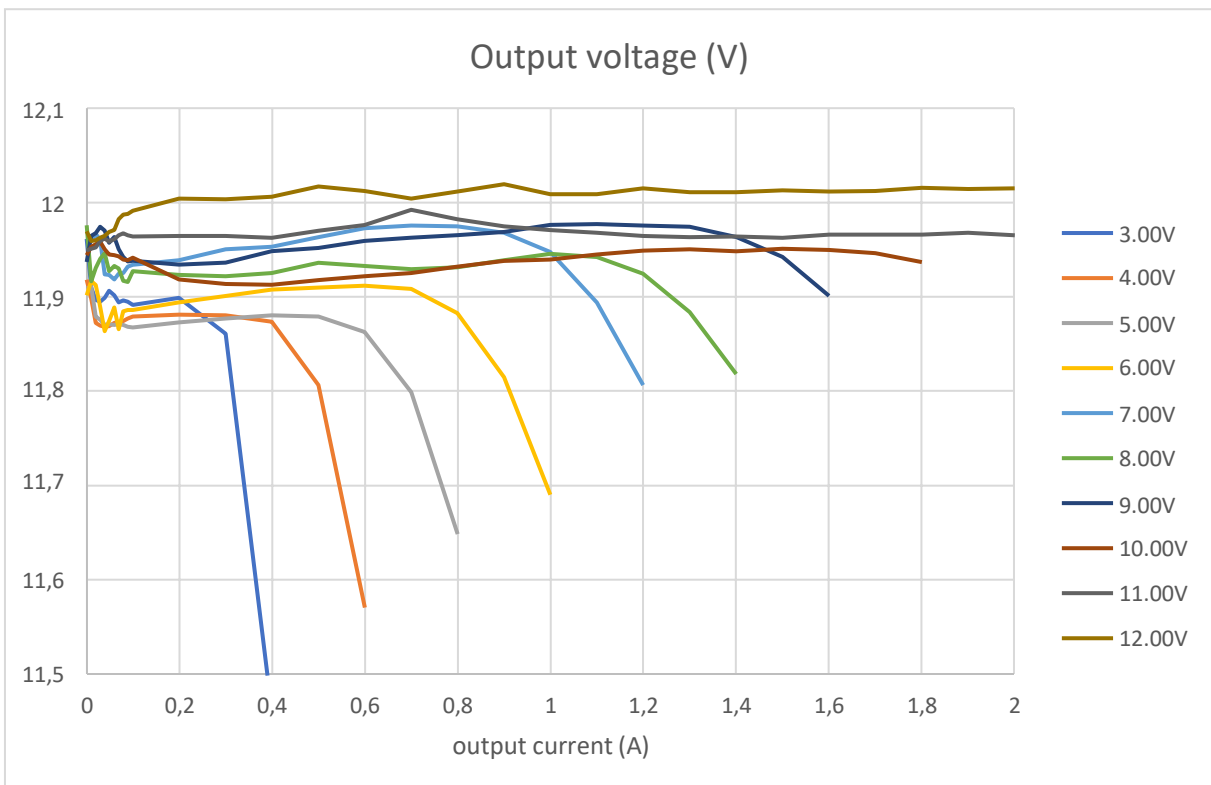
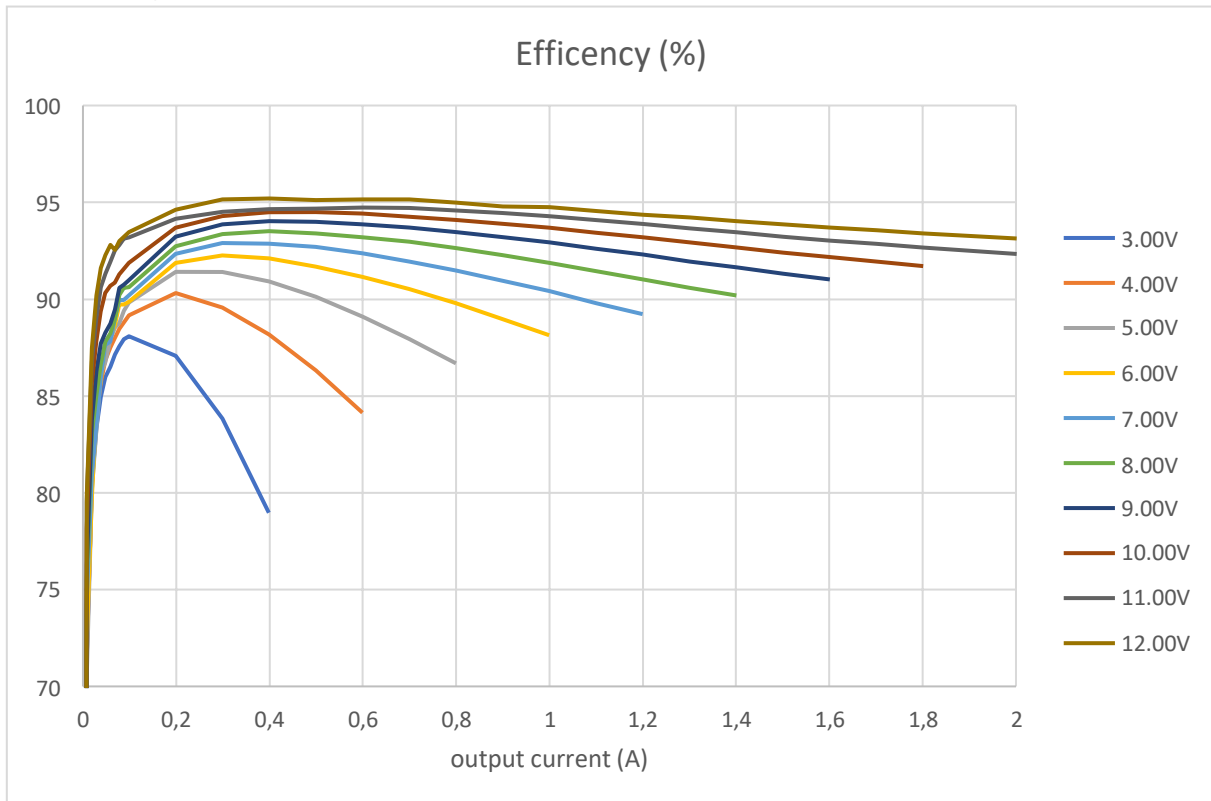

SX1308

Boost Converter

15V Output

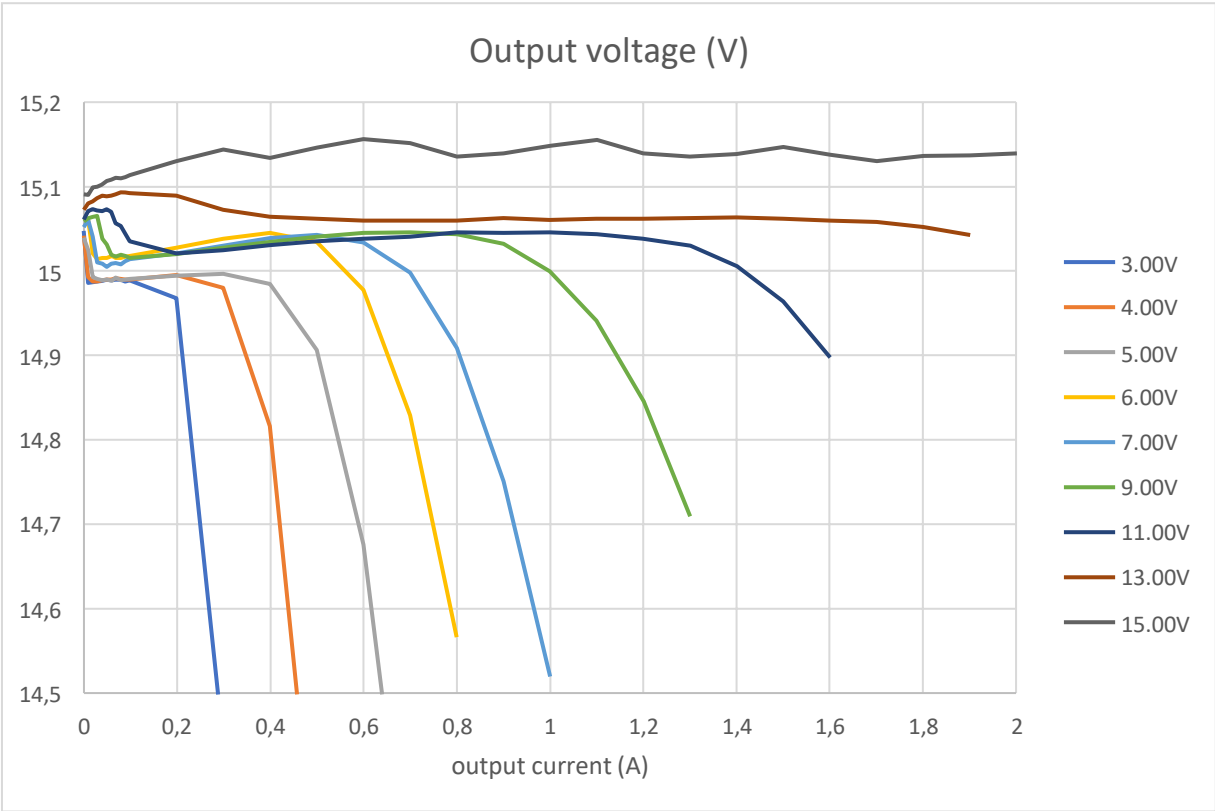
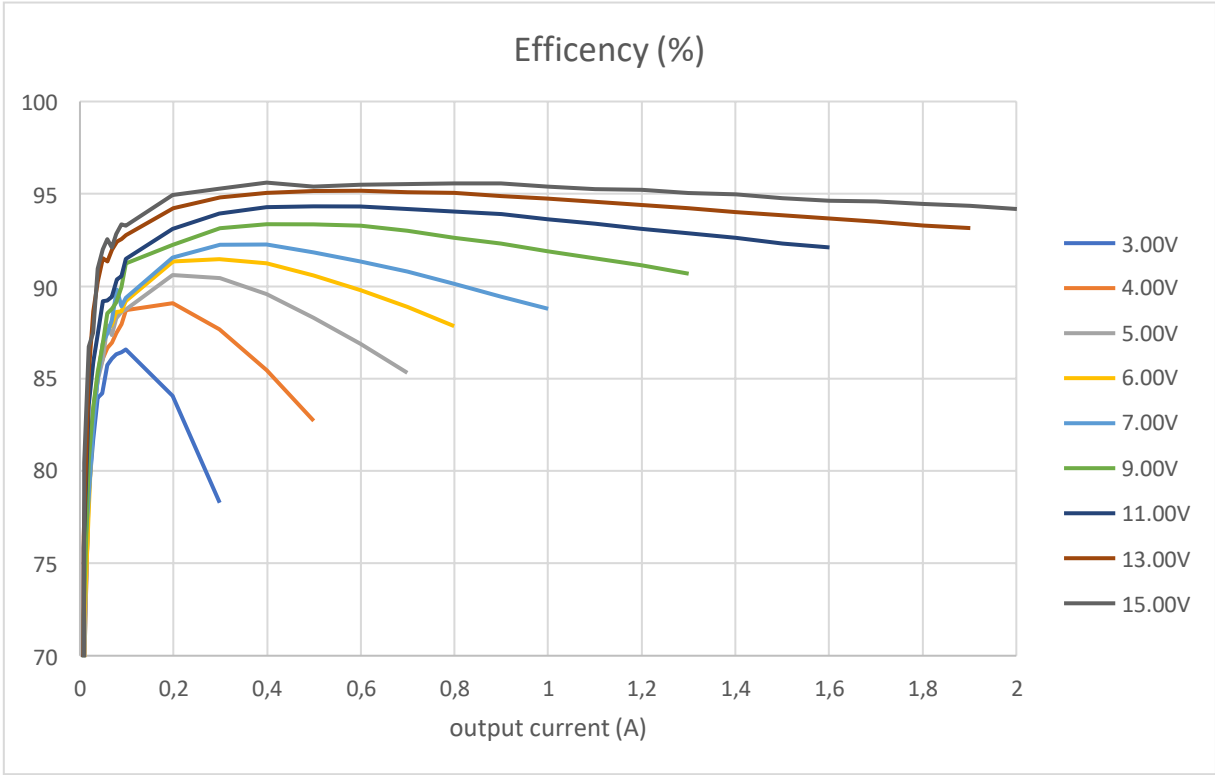

SX1308

Boost Converter

20V Output

